

Pole S technical info



a. fronte
b. retro
c. particolare struttura

a. front
b. back
c. structure detail

a. recto
b. verso
c. détail de la structure

a. Vorderseite
b. Rückseite
c. Strukturdetail

a. frente
b. trasera
c. particular de l'estructura

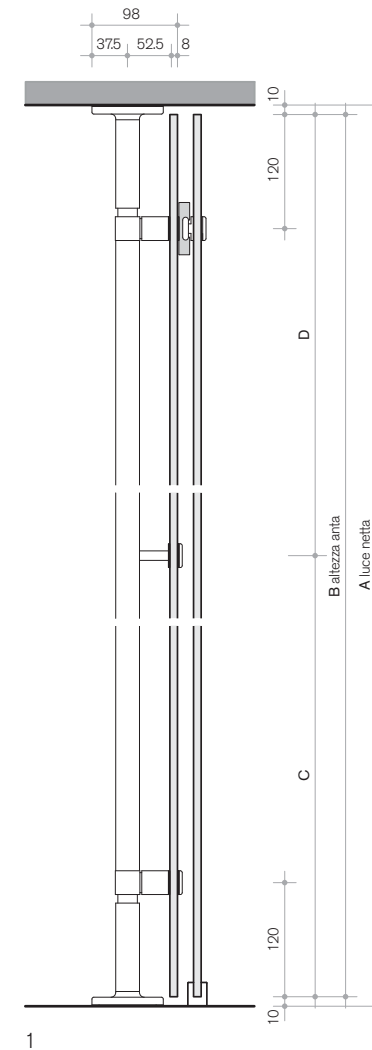

1

1. sezione verticale
2. sezione orizzontale scorrevole su parete Pole
3. sezione orizzontale scorrevole su muro

1. vertical section
2. horizontal section sliding door on Pole wall
3. horizontal section sliding door on wall

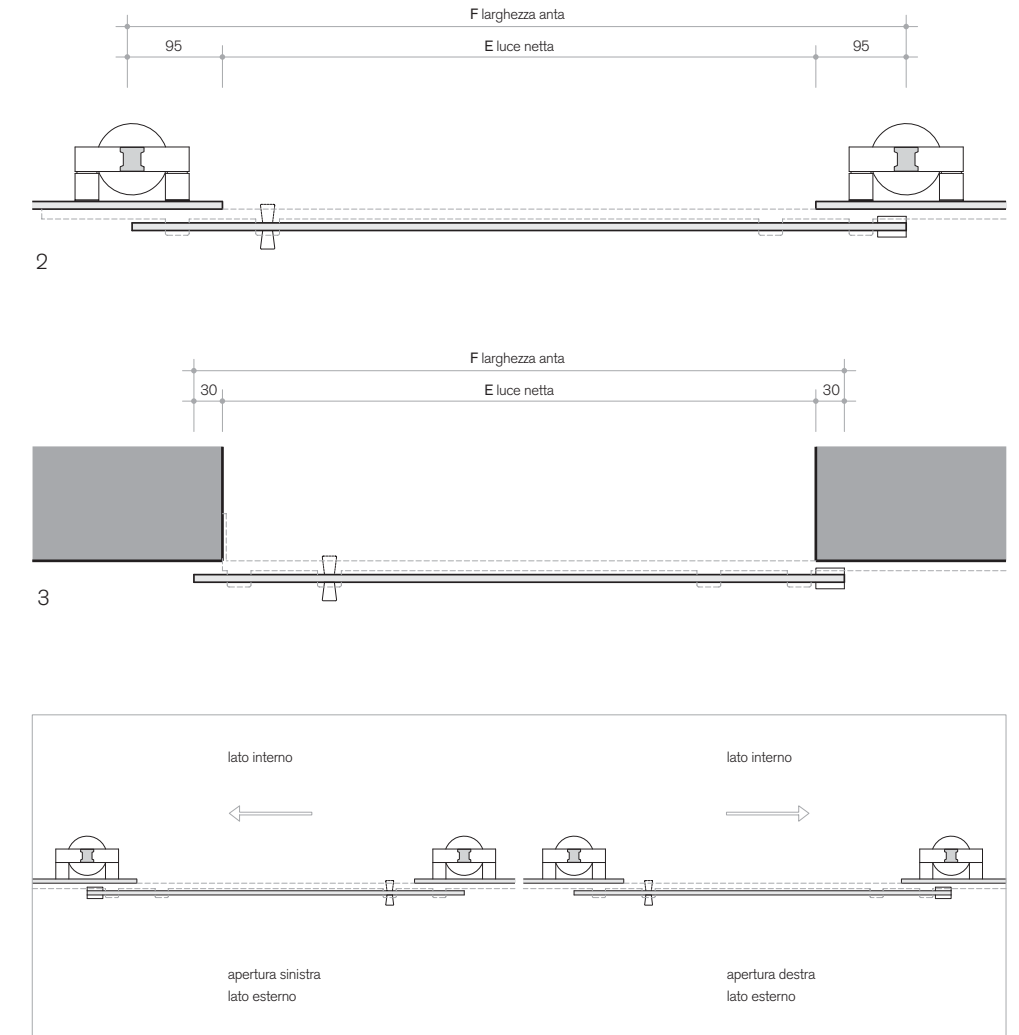

3

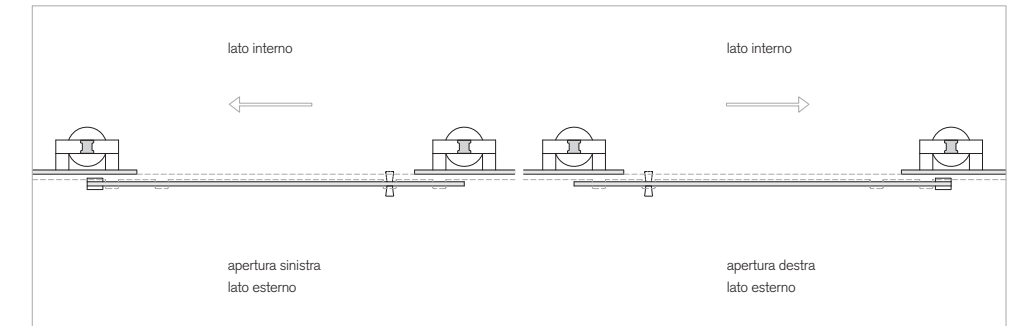

1. section verticale
2. section horizontale coulissant sur cloison Pole
3. section horizontale coulissant au mur

1. Vertikalschnitt
2. Querschnitt der Schiebetür an die Pole Wand
3. Querschnitt der Schiebetür an di Wand

1. seccìon vertical
2. seccìon horizontal corredera en la pared Pole
3. seccìon horizontal corredera en la pared

Pole doors **general info**

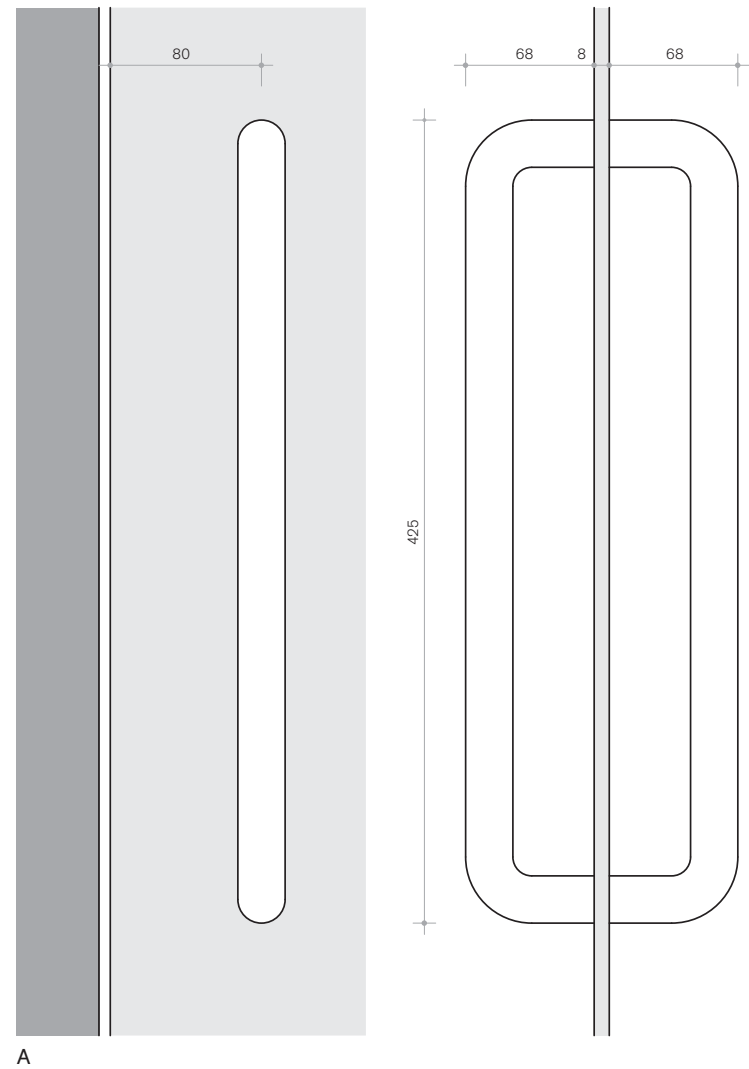

A

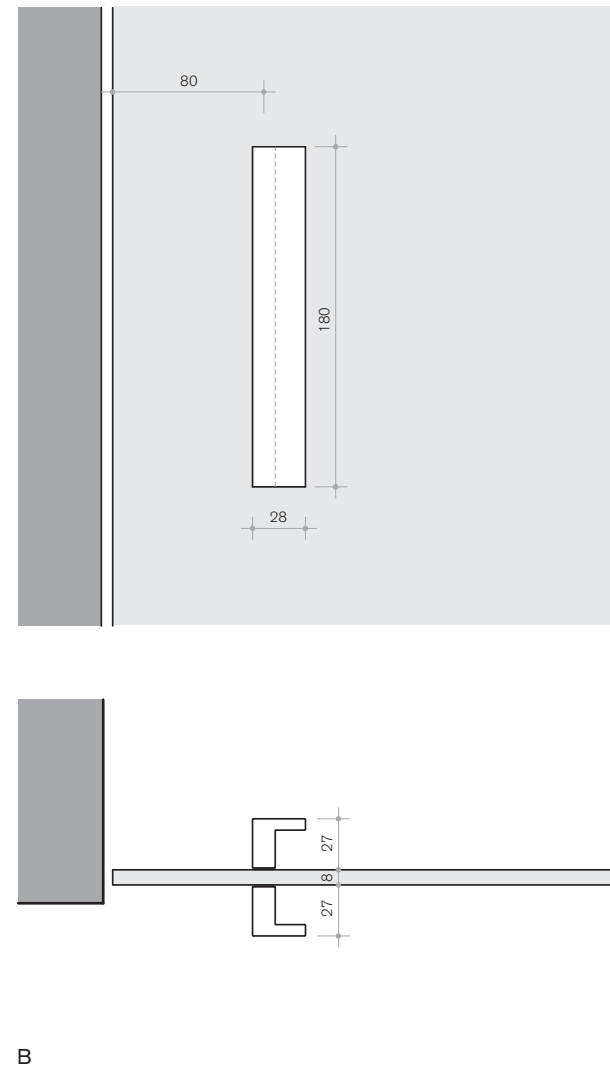

B

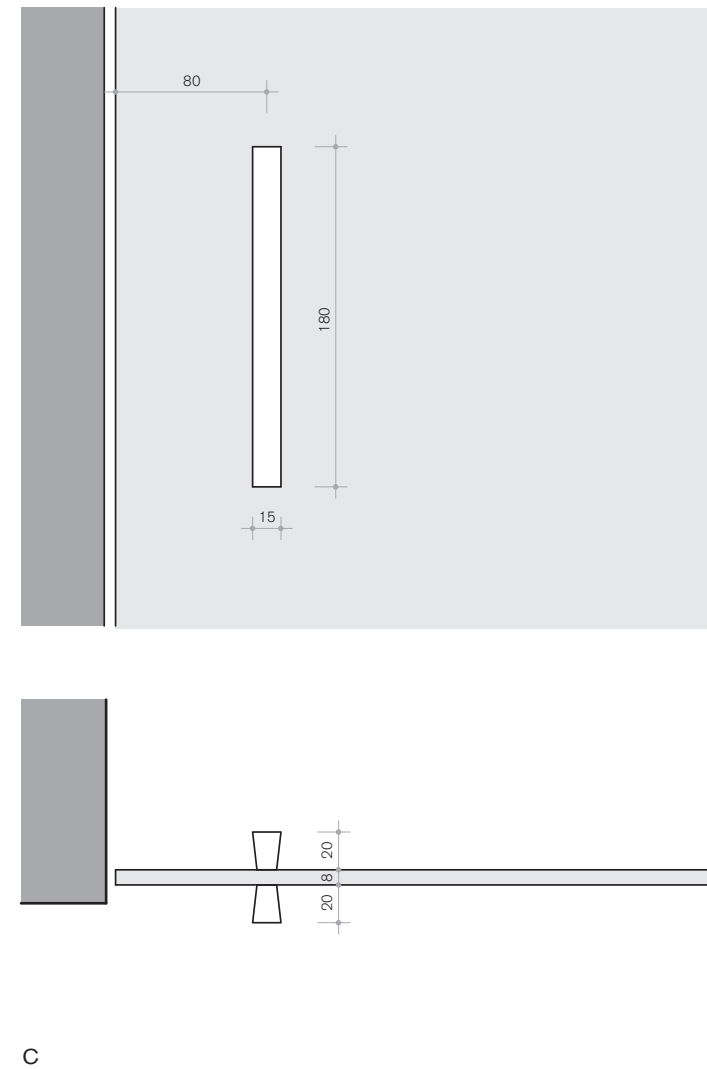

C

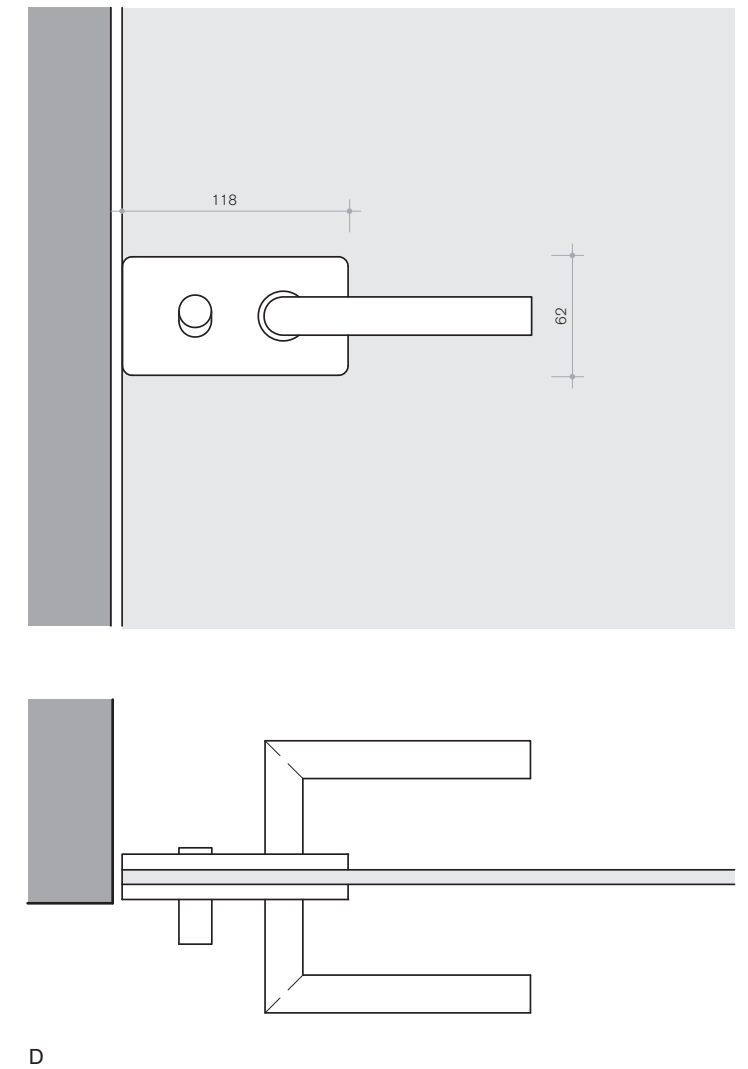

D

A. maniglione doppio
in alluminio anodizzato
B. maniglia a barretta
sezione "L"

A. large double handle
in anodised aluminium
B. L shape handle

A. grande poignée double
en aluminium anodisé
B. poignée en L

A. Großer Doppelgriff aus
eloxierten Aluminium
B. Griff in L-Form

A. manillón doble en
aluminio anodizado
B. manilla en L

C. maniglia a barretta
D. maniglia a leva
con chiavistello

C. bar handle
D. lever handle with latch

C. poignée en forme de barre
D. poignée de levier avec la
serrure

C. Griff in Stab-Form
D. Hebelgriff mit Schloss

C. manilla en forma de barra
D. manilla con el pestillo